

# 6

## Specials.



Prefix



Bending



Displays



Promotie

## Inhoudsopgave.

### Specials.

<b>Prefix:</b> voorgemonteerde producten	366 - 378
<b>Boren / frezen / zagen</b>	379 - 386, 401
<b>Bending:</b> 2-D en 3-D buigen	387 - 403
Bestelformulieren	404
<b>Displays en promotie</b>	405 - 407

## We maken het u graag zo makkelijk mogelijk.

### Direct aan de slag met Prefix

Heeft u te weinig mankracht voor een project? Laat ons dan het voorbereidende werk doen! Wij leveren de gewenste producten volgens uw specificaties kant-en-klaar bij u aan. Zodat u direct met de eindmontage kunt beginnen.

### Altijd een perfect gebogen buis met Bending

Wilt u perfect gebogen buis in 2D of 3D? Laat dat maar aan ons over. U geeft de juiste maten en buigingsgraad aan. Wij zorgen voor de oplossing op maat. Zo bespaart u tijd én dure machines. Bovendien loopt u geen enkel risico.

### Displays: groots resultaat in het klein

Wilt u klanten tonen hoe hun railingsysteem er uit komt te zien? Kies dan voor onze displays. Hiermee toont u op schaal direct een goed beeld van het eindresultaat. Makkelijk bij het maken van een weloverwogen keuze.

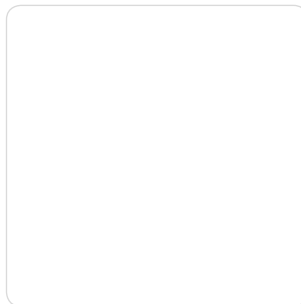



# Prefix

Q-line

Specials

Prijsaanvraag

Zie pagina  
216

MOD 0542 (H=970 mm)

- Ø 42,4 x 2,6 mm - 304
- Ø 42,4 x 2,6 mm - 316

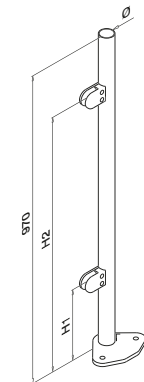
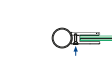
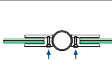
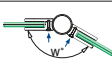
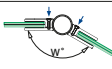
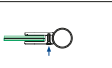
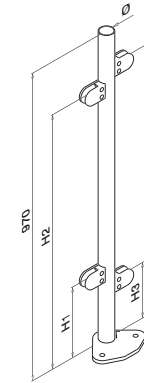
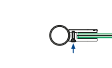
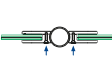
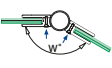
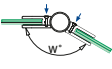
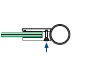
Uitvoering				Type	Aantal
<input type="checkbox"/>	Met glasklemmen  H1: _____ mm H2: _____ mm  	Glasklem <input type="checkbox"/> MOD 20 <input type="checkbox"/> MOD 21 <input type="checkbox"/> MOD 22 <input type="checkbox"/> MOD 24 <input type="checkbox"/> MOD 25 <input type="checkbox"/> MOD 26 <input type="checkbox"/> MOD 27 <input type="checkbox"/> MOD 28 <input type="checkbox"/> MOD 44 <input type="checkbox"/> MOD 46 <input type="checkbox"/> MOD 51 <input type="checkbox"/> MOD 52	Glasdikte <input type="checkbox"/> 8 mm <input type="checkbox"/> 8,76 mm <input type="checkbox"/> 10 mm <input type="checkbox"/> 10,76 mm <input type="checkbox"/> 12 mm <input type="checkbox"/> 12,76 mm	   W = _____ °  W = _____ ° 	
<input type="checkbox"/>	Met glasklemmen  H1: _____ mm H2: _____ mm H3: _____ mm H4: _____ mm  	Glasklem <input type="checkbox"/> MOD 20 <input type="checkbox"/> MOD 21 <input type="checkbox"/> MOD 22 <input type="checkbox"/> MOD 24 <input type="checkbox"/> MOD 25 <input type="checkbox"/> MOD 26 <input type="checkbox"/> MOD 27 <input type="checkbox"/> MOD 28 <input type="checkbox"/> MOD 44 <input type="checkbox"/> MOD 46 <input type="checkbox"/> MOD 51 <input type="checkbox"/> MOD 52	Glasdikte <input type="checkbox"/> 8 mm <input type="checkbox"/> 8,76 mm <input type="checkbox"/> 10 mm <input type="checkbox"/> 10,76 mm <input type="checkbox"/> 12 mm <input type="checkbox"/> 12,76 mm	   W = _____ °  W = _____ ° 	

Afzender

Naam

Telefoon

Firma

Fax

Straat, nr.

E-mail

Plaats

Klanummer



# Prefix

Q-line

Specials

Prijsaanvraag

Zie pagina  
216

MOD 0542 (H=970 mm)

- Ø 42,4 x 2,6 mm - 304
- Ø 42,4 x 2,6 mm - 316

Uitvoering		Type	Aantal
<input type="checkbox"/> Met dwarsstafhouders  H1: _____ mm H2: _____ mm		Dwarsstafhouders per baluster	
		_____ stuks	
		<input type="checkbox"/> MOD 0825 <input type="checkbox"/> MOD 0830 <input type="checkbox"/> MOD 0835 <input type="checkbox"/> MOD 0840 <input type="checkbox"/> MOD 0834 <input type="checkbox"/> MOD 0839	
		MOD 0834	
		MOD 0839	
		W = _____ °	
<input type="checkbox"/> Voor kabelsysteem  H1: _____ mm H2: _____ mm		Oogbouten per baluster	
		_____ stuks	
		d: <input type="checkbox"/> 3,2 mm <input type="checkbox"/> 6,0 mm	
		W = _____ °	

## Q-railing

Afzender

Naam

Telefoon

Firma

Fax

Straat, nr.

E-mail

Plaats

Klantnummer



# Prefix

Q-line

Specials

Prijsaanvraag

**MOD 0564 (H=1150 mm)**

Ø 42,4 x 2,0 mm - 304

**MOD 0544 (H=970 mm)**

Ø 42,4 x 2,6 mm - 304  
 Ø 48,3 x 2,6 mm - 304

Zie pagina  
227

Uitvoering				Type	Aantal
<input type="checkbox"/> Met glasklemmen  <input type="checkbox"/> H = 970 mm <input type="checkbox"/> H = 1150 mm  H1: _____ mm H2: _____ mm		<b>Glasklem</b> <input type="checkbox"/> MOD 20 <input type="checkbox"/> MOD 21 <input type="checkbox"/> MOD 22 <input type="checkbox"/> MOD 24 <input type="checkbox"/> MOD 25 <input type="checkbox"/> MOD 26 <input type="checkbox"/> MOD 27 <input type="checkbox"/> MOD 28 <input type="checkbox"/> MOD 44 <input type="checkbox"/> MOD 46 <input type="checkbox"/> MOD 51 <input type="checkbox"/> MOD 52	<b>Glasdikte</b> <input type="checkbox"/> 8 mm <input type="checkbox"/> 8,76 mm <input type="checkbox"/> 10 mm <input type="checkbox"/> 10,76 mm <input type="checkbox"/> 12 mm <input type="checkbox"/> 12,76 mm		
					W = _____ °
					W = _____ °
<input type="checkbox"/> Met glasklemmen  <input type="checkbox"/> H = 970 mm <input type="checkbox"/> H = 1150 mm  H1: _____ mm H2: _____ mm H3: _____ mm H4: _____ mm		<b>Glasklem</b> <input type="checkbox"/> MOD 20 <input type="checkbox"/> MOD 21 <input type="checkbox"/> MOD 22 <input type="checkbox"/> MOD 24 <input type="checkbox"/> MOD 25 <input type="checkbox"/> MOD 26 <input type="checkbox"/> MOD 27 <input type="checkbox"/> MOD 28 <input type="checkbox"/> MOD 44 <input type="checkbox"/> MOD 46 <input type="checkbox"/> MOD 51 <input type="checkbox"/> MOD 52	<b>Glasdikte</b> <input type="checkbox"/> 8 mm <input type="checkbox"/> 8,76 mm <input type="checkbox"/> 10 mm <input type="checkbox"/> 10,76 mm <input type="checkbox"/> 12 mm <input type="checkbox"/> 12,76 mm		
					W = _____ °
					W = _____ °

Afzender

Naam \_\_\_\_\_

Telefoon \_\_\_\_\_

Firma \_\_\_\_\_

Fax \_\_\_\_\_

Straat, nr. \_\_\_\_\_

E-mail \_\_\_\_\_

Plaats \_\_\_\_\_

Klantnummer \_\_\_\_\_



# Prefix

Q-line

Specials

Prijsaanvraag

MOD 0564 (H=1150 mm)

Ø 42,4 x 2,0 mm - 304

MOD 0544 (H=970 mm)

Ø 42,4 x 2,6 mm - 304  
 Ø 48,3 x 2,6 mm - 304

Zie pagina  
227

Uitvoering		Type	Aantal													
<input type="checkbox"/> Met dwarsstafhouders  <input type="checkbox"/> H = 970 mm <input type="checkbox"/> H = 1150 mm  H1: _____ mm H2: _____ mm		Dwarsstafhouders per baluster														
		_____ stuks														
		<input type="checkbox"/> MOD 0825 <input type="checkbox"/> MOD 0830 <input type="checkbox"/> MOD 0835 <input type="checkbox"/> MOD 0840 <input type="checkbox"/> MOD 0834 <input type="checkbox"/> MOD 0839														
		<table border="1"> <tr> <td></td> <td>MOD 0834</td> <td></td> </tr> <tr> <td></td> <td>MOD 0839</td> <td></td> </tr> <tr> <td></td> <td></td> <td></td> </tr> <tr> <td></td> <td></td> <td></td> </tr> <tr> <td></td> <td>W = _____ °</td> <td></td> </tr> </table>			MOD 0834			MOD 0839								
	MOD 0834															
	MOD 0839															
	W = _____ °															
<input type="checkbox"/> Voor kabelsysteem  <input type="checkbox"/> H = 970 mm <input type="checkbox"/> H = 1150 mm  H1: _____ mm H2: _____ mm		Oogbouten per baluster														
		_____ stuks														
		d: <input type="checkbox"/> 3,2 mm <input type="checkbox"/> 6,0 mm														
		<table border="1"> <tr> <td></td> <td></td> <td></td> </tr> <tr> <td></td> <td></td> <td></td> </tr> <tr> <td></td> <td>W = _____ °</td> <td></td> </tr> </table>									W = _____ °					
	W = _____ °															

## Q-railing

Afzender

Naam \_\_\_\_\_

Telefoon \_\_\_\_\_

Firma \_\_\_\_\_

Fax \_\_\_\_\_

Straat, nr. \_\_\_\_\_

E-mail \_\_\_\_\_

Plaats \_\_\_\_\_

Klantnummer \_\_\_\_\_



# Prefix

Q-line

Specials









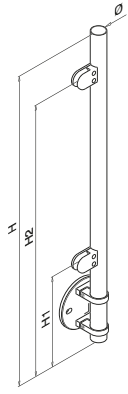

Prijsaanvraag

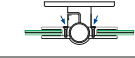
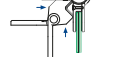
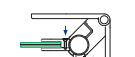
- Ø 42,4 x 2,0 mm - 304
- Ø 48,3 x 2,0 mm - 304
- Ø 42,4 x 2,0 mm - 316
- Ø 48,3 x 2,0 mm - 316

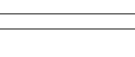
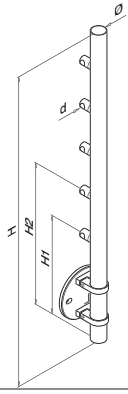
- MOD 0551
- MOD 0552
- MOD 0553
- MOD 0555

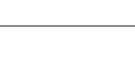
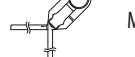
- Ø 42,4 x 2,6 mm - 304
- Ø 48,3 x 2,6 mm - 304
- Ø 42,4 x 2,6 mm - 316
- Ø 48,3 x 2,6 mm - 316

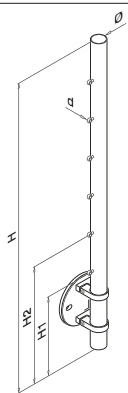
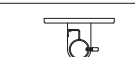
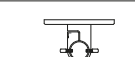
Zie pagina  
230

Uitvoering				Type	Aantal
<input type="checkbox"/>	Met glasklemmen  H: _____ mm H1: _____ mm H2: _____ mm  	Glasklem <input type="checkbox"/> MOD 20 <input type="checkbox"/> MOD 21 <input type="checkbox"/> MOD 22 <input type="checkbox"/> MOD 24 <input type="checkbox"/> MOD 25 <input type="checkbox"/> MOD 26 <input type="checkbox"/> MOD 27 <input type="checkbox"/> MOD 28 <input type="checkbox"/> MOD 44 <input type="checkbox"/> MOD 46 <input type="checkbox"/> MOD 51 <input type="checkbox"/> MOD 52	Glasdikte <input type="checkbox"/> 8 mm <input type="checkbox"/> 8,76 mm <input type="checkbox"/> 10 mm <input type="checkbox"/> 10,76 mm <input type="checkbox"/> 12 mm <input type="checkbox"/> 12,76 mm	     	
<input type="checkbox"/>	Met dwarsstafhouders  H: _____ mm H1: _____ mm H2: _____ mm  	Dwarsstafhouders per baluster _____ stuks  <input type="checkbox"/> MOD 0825 <input type="checkbox"/> MOD 0830 <input type="checkbox"/> MOD 0835 <input type="checkbox"/> MOD 0840 <input type="checkbox"/> MOD 0834 <input type="checkbox"/> MOD 0839		   MOD 0834  MOD 0839	
<input type="checkbox"/>	Voor kabelsysteem  H: _____ mm H1: _____ mm H2: _____ mm  	Oogbouten per baluster _____ stuks  d: <input type="checkbox"/> 3,2 mm <input type="checkbox"/> 6,0 mm		   	

Specials

## Q-railing

Afzender

Naam

Telefoon

Firma

Fax

Straat, nr.

E-mail

Plaats

Klantnummer



# Prefix

Q-line

Specials

Prijsaanvraag

**MOD 0944 (H=1150 mm)**

- Ø 42,4 x 2,0 mm - 304
- Ø 48,3 x 2,0 mm - 304
- Ø 42,4 x 2,0 mm - 316
- Ø 48,3 x 2,0 mm - 316

Zie pagina  
217, 218

- MOD 0913 (H=970 mm)
- MOD 0914 (H=970 mm)

- Ø 42,4 x 2,6 mm - 304
- Ø 48,3 x 2,6 mm - 304
- Ø 42,4 x 2,6 mm - 316
- Ø 48,3 x 2,6 mm - 316

- Ø 42,4 x 2,0 mm - 304
- Ø 48,3 x 2,0 mm - 304
- Ø 42,4 x 2,0 mm - 316
- Ø 48,3 x 2,0 mm - 316

Uitvoering		Type	Aantal
<input type="checkbox"/> Met glasklemmen  <input type="checkbox"/> H = 970 mm <input type="checkbox"/> H = 1150 mm  H1: _____ mm H2: _____ mm		Glasklem <input type="checkbox"/> MOD 20 <input type="checkbox"/> MOD 21 <input type="checkbox"/> MOD 22 <input type="checkbox"/> MOD 24 <input type="checkbox"/> MOD 25 <input type="checkbox"/> MOD 26 <input type="checkbox"/> MOD 27 <input type="checkbox"/> MOD 28 <input type="checkbox"/> MOD 44 <input type="checkbox"/> MOD 46 <input type="checkbox"/> MOD 51 <input type="checkbox"/> MOD 52  Glasdikte <input type="checkbox"/> 8 mm <input type="checkbox"/> 8,76 mm <input type="checkbox"/> 10 mm <input type="checkbox"/> 10,76 mm <input type="checkbox"/> 12 mm <input type="checkbox"/> 12,76 mm	
<input type="checkbox"/> Met dwarsstafhouders  <input type="checkbox"/> H = 970 mm <input type="checkbox"/> H = 1150 mm  H1: _____ mm H2: _____ mm		Dwarsstafhouders per baluster _____ stuks  d: <input type="checkbox"/> 12 mm <input type="checkbox"/> 16 mm	
<input type="checkbox"/> Voor kabelsysteem  <input type="checkbox"/> H = 970 mm <input type="checkbox"/> H = 1150 mm  H1: _____ mm H2: _____ mm		Oogbouten per baluster _____ stuks  d: <input type="checkbox"/> 3,2 mm <input type="checkbox"/> 6,0 mm	

Q-railing

Afzender

Naam \_\_\_\_\_

Firma \_\_\_\_\_

Straat, nr. \_\_\_\_\_

Plaats \_\_\_\_\_

Telefoon \_\_\_\_\_

Fax \_\_\_\_\_

E-mail \_\_\_\_\_

Klantnummer \_\_\_\_\_



# Prefix

Q-line

Specials

Prijsaanvraag

Zie pagina  
216

MOD 0542 (H=970 mm)

- Ø 42,4 x 2,6 mm - 304
- Ø 48,3 x 2,6 mm - 304
- Ø 42,4 x 2,6 mm - 316
- Ø 48,3 x 2,6 mm - 316

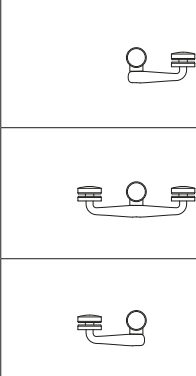
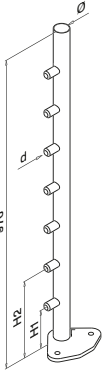
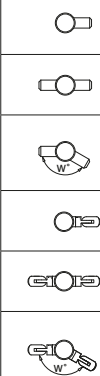
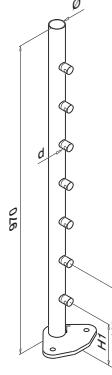
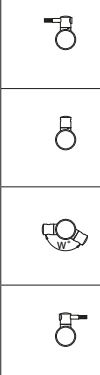
Uitvoering		Type	Aantal
<input type="checkbox"/> Met Spider  H1: _____ mm H2: _____ mm	 <p>Spider</p> <ul style="list-style-type: none"> <li><input type="checkbox"/> MOD 0750</li> <li><input type="checkbox"/> MOD 0751</li> <li><input type="checkbox"/> MOD 0752</li> <li><input type="checkbox"/> MOD 0753</li> </ul>		
<input type="checkbox"/> Met stafhouders  H1: _____ mm H2: _____ mm	 <p>Stafhouders per baluster</p> <p>_____ stuks</p> <p>d = 12 mm</p> <ul style="list-style-type: none"> <li><input type="checkbox"/> Recht</li> <li><input type="checkbox"/> Variabel</li> </ul>	 <p>W = _____ °</p> <p>W = _____ °</p>	
<input type="checkbox"/> Voor kabelsysteem  H1: _____ mm H2: _____ mm	 <p>Kabelhouder</p> <p>_____ stuks</p> <p>d = 3,2 mm</p>	 <p>W = _____ °</p>	

Q-railing

Afzender

Naam \_\_\_\_\_

Firma \_\_\_\_\_

Straat, nr. \_\_\_\_\_

Plaats \_\_\_\_\_

Telefoon \_\_\_\_\_

Fax \_\_\_\_\_

E-mail \_\_\_\_\_

Klanummer \_\_\_\_\_





# Prefix

Q-line

Specials

Prijsaanvraag

MOD 0564 (H=1150 mm)

- Ø 42,4 x 2,0 mm - 304
- Ø 48,3 x 2,0 mm - 304
- Ø 42,4 x 2,0 mm - 316

MOD 0544 (H=970 mm)

- Ø 42,4 x 2,6 mm - 304
- Ø 48,3 x 2,6 mm - 304
- Ø 42,4 x 2,6 mm - 316

Zie pagina  
227

Uitvoering		Type	Aantal
<input type="checkbox"/> Met Spider  H1: _____ mm H2: _____ mm		Spider <input type="checkbox"/> MOD 0750 <input type="checkbox"/> MOD 0751 <input type="checkbox"/> MOD 0752 <input type="checkbox"/> MOD 0753	
<input type="checkbox"/> Met stafhouders  H1: _____ mm H2: _____ mm		Stafhouders per baluster _____ stuks  d = 12 mm	<input type="checkbox"/> Rechthoekig 
			<input type="checkbox"/> Variabel 
			W = _____ °
			W = _____ °
<input type="checkbox"/> Voor kabelsysteem  H1: _____ mm H2: _____ mm		Kabelhouder _____ stuks  d = 3,2 mm	
			W = _____ °

Q-railing

Afzender

Naam \_\_\_\_\_

Firma \_\_\_\_\_

Straat, nr. \_\_\_\_\_

Plaats \_\_\_\_\_

Telefoon \_\_\_\_\_

Fax \_\_\_\_\_

E-mail \_\_\_\_\_

Klantnummer \_\_\_\_\_



# Prefix

Q-line

Specials

Prijsaanvraag











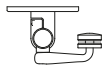
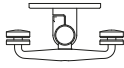
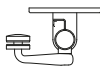
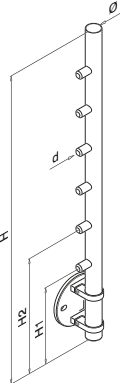

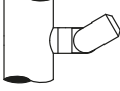

- MOD 0551
- MOD 0552
- MOD 0553
- MOD 0555

- Ø 42,4 x 2,0 mm - 304
- Ø 48,3 x 2,0 mm - 304
- Ø 42,4 x 2,0 mm - 316
- Ø 48,3 x 2,0 mm - 316

- MOD 0551
- MOD 0552
- MOD 0553
- MOD 0555

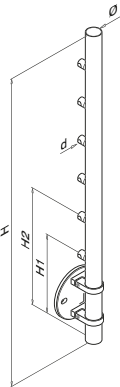
- Ø 42,4 x 2,6 mm - 304
- Ø 48,3 x 2,6 mm - 304
- Ø 42,4 x 2,6 mm - 316
- Ø 48,3 x 2,6 mm - 316

Zie pagina  
230

Uitvoering		Type		Aantal	
<input type="checkbox"/>	<p>Met Spider</p> <p>H: _____ mm</p> <p>H1: _____ mm</p> <p>H2: _____ mm</p> 	<p>Spider</p> <ul style="list-style-type: none"> <li><input type="checkbox"/> MOD 0750</li> <li><input type="checkbox"/> MOD 0751</li> <li><input type="checkbox"/> MOD 0752</li> <li><input type="checkbox"/> MOD 0753</li> </ul>	  		
<input type="checkbox"/>	<p>Met stafhouders</p> <p>H: _____ mm</p> <p>H1: _____ mm</p> <p>H2: _____ mm</p> 	<p>Stafhouders per baluster</p> <p>_____ stuks</p> <p>d = 12 mm</p> <ul style="list-style-type: none"> <li><input type="checkbox"/> Rech</li> <li><input type="checkbox"/> Variabel</li> </ul>  	       		
<input type="checkbox"/>	<p>Voor kabelsysteem</p> <p>H: _____ mm</p> <p>H1: _____ mm</p> <p>H2: _____ mm</p> 	<p>Kabelhouder</p> <p>_____ stuks</p> <p>d = 3,2 mm</p>	  		

Specials

## Q-railing

Afzender

Naam \_\_\_\_\_

Firma \_\_\_\_\_

Straat, nr. \_\_\_\_\_

Plaats \_\_\_\_\_

Telefoon \_\_\_\_\_

Fax \_\_\_\_\_

E-mail \_\_\_\_\_

Klantnummer \_\_\_\_\_



# Prefix

Q-line

Specials

Prijsaanvraag

**MOD 0944 (H=1150 mm)**

- Ø 42,4 x 2,0 mm - 304
- Ø 48,3 x 2,0 mm - 304
- Ø 42,4 x 2,0 mm - 316
- Ø 48,3 x 2,0 mm - 316

Zie pagina  
217, 218

- MOD 0913 (H=970 mm)
- MOD 0914 (H=970 mm)

- Ø 42,4 x 2,6 mm - 304
- Ø 48,3 x 2,6 mm - 304
- Ø 42,4 x 2,6 mm - 316
- Ø 48,3 x 2,6 mm - 316

- Ø 42,4 x 2,0 mm - 304
- Ø 48,3 x 2,0 mm - 304
- Ø 42,4 x 2,0 mm - 316
- Ø 48,3 x 2,0 mm - 316

Uitvoering	Type	Aantal
<input type="checkbox"/> Met Spider <input type="checkbox"/> H = 970 mm <input type="checkbox"/> H = 1150 mm H1: _____ mm H2: _____ mm	Spider <input type="checkbox"/> MOD 0750 <input type="checkbox"/> MOD 0751 <input type="checkbox"/> MOD 0752 <input type="checkbox"/> MOD 0753	
<input type="checkbox"/> Met stafhouders <input type="checkbox"/> H = 970 mm <input type="checkbox"/> H = 1150 mm H1: _____ mm H2: _____ mm	Stafhouders per baluster _____ stuks d = 12 mm <input type="checkbox"/> Rech <input type="checkbox"/> Variabel	
<input type="checkbox"/> Voor kabelsysteem <input type="checkbox"/> H = 970 mm <input type="checkbox"/> H = 1150 mm H1: _____ mm H2: _____ mm	Kabelhouder _____ stuks d = 3,2 mm	

Q-railing

Afzender

Naam \_\_\_\_\_

Firma \_\_\_\_\_

Straat, nr. \_\_\_\_\_

Plaats \_\_\_\_\_

Telefoon \_\_\_\_\_

Fax \_\_\_\_\_

E-mail \_\_\_\_\_

Klantnummer \_\_\_\_\_



# Prefix

Square Line®

Specials

Prijsaanvraag

Zie pagina  
161

MOD 4913 (H=970 mm)

- 40 x 40 x 2,0 mm - 304
- 40 x 40 x 2,0 mm - 316

Uitvoering		Type	Aantal		
<input type="checkbox"/> Met glasklemmen  H1: _____ mm H2: _____ mm		Glasklem <input type="checkbox"/> MOD 20 <input type="checkbox"/> MOD 21 <input type="checkbox"/> MOD 22 <input type="checkbox"/> MOD 24 <input type="checkbox"/> MOD 25 <input type="checkbox"/> MOD 26 <input type="checkbox"/> MOD 27 <input type="checkbox"/> MOD 28 <input type="checkbox"/> MOD 44 <input type="checkbox"/> MOD 46 <input type="checkbox"/> MOD 51 <input type="checkbox"/> MOD 52	Glasdikte <input type="checkbox"/> 8 mm <input type="checkbox"/> 8,76 mm <input type="checkbox"/> 10 mm <input type="checkbox"/> 10,76 mm <input type="checkbox"/> 12 mm <input type="checkbox"/> 12,76 mm <input type="checkbox"/> 16,76 mm		
<input type="checkbox"/> Met dwarsstafhouders  H1: _____ mm H2: _____ mm		Dwarsstafhouders per baluster _____ stuks  <input type="checkbox"/> MOD 4820 <input type="checkbox"/> MOD 4821 <input type="checkbox"/> MOD 4822 <input type="checkbox"/> MOD 4823			
<input type="checkbox"/> Voor kabelsysteem  <input type="checkbox"/> H = 970 mm <input type="checkbox"/> H = 1150 mm  H1: _____ mm H2: _____ mm		Oogbouten per baluster _____ stuks  d: <input type="checkbox"/> 3,2 mm <input type="checkbox"/> 6,0 mm			

Specials



Afzender

Naam

Telefoon

Firma

Fax

Straat, nr.

E-mail

Plaats

Klantnummer



# Prefix

Square Line®







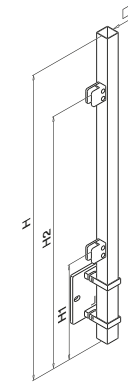

Specials

Prijsaanvraag

Zie pagina  
163

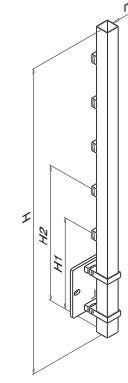
MOD 4551

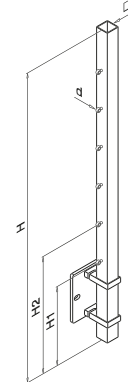
40 x 40 x 2,0 mm - 304

Uitvoering		Type	Aantal		
<input type="checkbox"/> Met glasklemmen  H: _____ mm H1: _____ mm H2: _____ mm		Glasklem <input type="checkbox"/> MOD 20 <input type="checkbox"/> MOD 21 <input type="checkbox"/> MOD 22 <input type="checkbox"/> MOD 24 <input type="checkbox"/> MOD 25 <input type="checkbox"/> MOD 26 <input type="checkbox"/> MOD 27 <input type="checkbox"/> MOD 28 <input type="checkbox"/> MOD 44 <input type="checkbox"/> MOD 46 <input type="checkbox"/> MOD 51 <input type="checkbox"/> MOD 52	Glasdikte <input type="checkbox"/> 8 mm <input type="checkbox"/> 8,76 mm <input type="checkbox"/> 10 mm <input type="checkbox"/> 10,76 mm <input type="checkbox"/> 12 mm <input type="checkbox"/> 12,76 mm <input type="checkbox"/> 16,76 mm	  	
<input type="checkbox"/> Met dwarsstafhouders  H: _____ mm H1: _____ mm H2: _____ mm		Dwarsstafhouders per baluster _____ stuks  <input type="checkbox"/> MOD 4820 <input type="checkbox"/> MOD 4821 <input type="checkbox"/> MOD 4822 <input type="checkbox"/> MOD 4823			
<input type="checkbox"/> Voor kabelsysteem  H: _____ mm H1: _____ mm H2: _____ mm		Oogbouten per baluster _____ stuks  d: <input type="checkbox"/> 3,2 mm <input type="checkbox"/> 6,0 mm		 	

## Q-railing

Afzender

Naam

Telefoon

Firma

Fax

Straat, nr.

E-mail

Plaats

Klantnummer



# Prefix

Square Line®

Specials

Prijsaanvraag

Zie pagina  
161

MOD 4913 (H=970 mm)

- 40 x 40 x 2,0 mm - 304
- 40 x 40 x 2,0 mm - 316

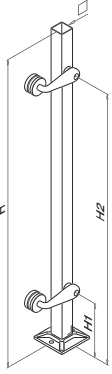
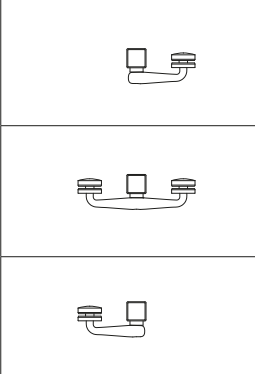
Uitvoering		Type	Aantal
<input type="checkbox"/> Met Spider  H1: _____ mm H2: _____ mm	 <p>Spider</p> <ul style="list-style-type: none"> <li><input type="checkbox"/> MOD 0750</li> <li><input type="checkbox"/> MOD 0751</li> <li><input type="checkbox"/> MOD 0752</li> <li><input type="checkbox"/> MOD 0753</li> <li><input type="checkbox"/> MOD 4752</li> <li><input type="checkbox"/> MOD 4753</li> <li><input type="checkbox"/> MOD 4754</li> </ul>		

Afzender

Naam

Telefoon

Firma

Fax

Straat, nr.

E-mail

Plaats

Klantnummer







# Boren

(ronde buis)

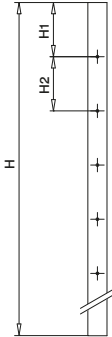
Specials

Prijsaanvraag

Uitvoering	Type	Aantal		Draadtappen				
		Buizen	Gaten	 $\emptyset$ mm	M6	M8	M10	
<input type="checkbox"/> <p>H: _____ mm</p> <p>H1: _____ mm</p> <p>H2: _____ mm</p> <p>W1: _____ °</p> 	<input type="checkbox"/> 				<input type="checkbox"/>	<input type="checkbox"/>	<input type="checkbox"/>	
					<input type="checkbox"/>	<input type="checkbox"/>	<input type="checkbox"/>	
	<input type="checkbox"/> 				<input type="checkbox"/>	<input type="checkbox"/>	<input type="checkbox"/>	
					<input type="checkbox"/>	<input type="checkbox"/>	<input type="checkbox"/>	
	<input type="checkbox"/> 	<input type="checkbox"/> 				<input type="checkbox"/>	<input type="checkbox"/>	<input type="checkbox"/>
						<input type="checkbox"/>	<input type="checkbox"/>	<input type="checkbox"/>
					<input type="checkbox"/>	<input type="checkbox"/>	<input type="checkbox"/>	



Afzender

Naam

Telefoon

Firma

Fax

Straat, nr.

E-mail

Plaats

Klantnummer



Specials

Prijsaanvraag

# Frezen / Zagen

(ronde buis voor LED-spots)

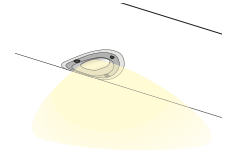

		2500 mm	5000 mm	304 Geslepen	316 Geslepen
○	Ø 42,4 x 2,0 mm	<input type="checkbox"/>	<input type="checkbox"/>	<input type="checkbox"/>	<input type="checkbox"/>
○	Ø 48,3 x 2,0 mm	<input type="checkbox"/>	<input type="checkbox"/>	<input type="checkbox"/>	<input type="checkbox"/>
Aantal: _____					

## Frezen

(gaten voor LED-spots)

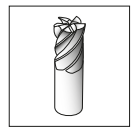

$L_1 =$ _____ mm (min. 55) $L_2 =$ _____ mm Aantal: _____	
---	--

## Zagen

(buis met voorgezaagde gaten voor LED-spots)

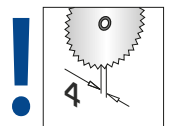

$X = 90^\circ$ $L_1 =$ _____ mm $L_2 =$ _____ mm	
--	--

Wilt u een voorgezaagde buis in een schuine hoek? Neem dan contact met ons op.

Restlengtes worden meegestuurd.

Specials



Afzender

Naam

Telefoon

Firma

Fax

Straat, nr.

E-mail

Plaats

Klanummer





Specials  
Prijsaanvraag

# Zagen

(vierkante staven en buizen)

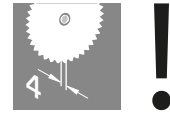

	2500 mm	5000 mm	304 Geslepen	316 Geslepen
15 x 5 mm	<input type="checkbox"/>	<input type="checkbox"/>	<input type="checkbox"/>	<input type="checkbox"/>
40 x 10 x 1,5 mm	<input type="checkbox"/>	<input type="checkbox"/>	<input type="checkbox"/>	<input type="checkbox"/>
40 x 40 x 2,0 mm	<input type="checkbox"/>	<input type="checkbox"/>	<input type="checkbox"/>	<input type="checkbox"/>
Aantal: _____				

## rechte zaagsnede

$X = 90^\circ$ $L_1 = \text{_____ mm}$ $L_2 = \text{_____ mm}$	
--	--

## diagonale zaagsnede vertikaal

$X = \text{_____}^\circ$ $L_1 = \text{_____ mm}$ $L_2 = \text{_____ mm}$	
$X = \text{_____}^\circ$ $L_1 = \text{_____ mm}$ $L_2 = \text{_____ mm}$	

## diagonale zaagsnede horizontaal

$X = \text{_____}^\circ$ $L_1 = \text{_____ mm}$ $L_2 = \text{_____ mm}$	
$X = \text{_____}^\circ$ $L_1 = \text{_____ mm}$ $L_2 = \text{_____ mm}$	



Afzender

Naam \_\_\_\_\_

Telefoon \_\_\_\_\_

Firma \_\_\_\_\_

Fax \_\_\_\_\_

Straat, nr. \_\_\_\_\_

E-mail \_\_\_\_\_

Plaats \_\_\_\_\_

Klantnummer \_\_\_\_\_



Specials

Prijsaanvraag

# Zagen

(staf en buis)



		2500 mm	3000 mm	5000 mm	304 Geslepen	316 Geslepen	304 Gepolijst	316 Gepolijst	Koolstofstaal
●	Ø 10 mm	<input type="checkbox"/>		<input type="checkbox"/>	<input type="checkbox"/>				
●	Ø 12 mm	<input type="checkbox"/>		<input type="checkbox"/>	<input type="checkbox"/>	<input type="checkbox"/>	<input type="checkbox"/>	<input type="checkbox"/>	
●	Ø 14 mm	<input type="checkbox"/>		<input type="checkbox"/>	<input type="checkbox"/>				
○	Ø 12 x 1,0 mm	<input type="checkbox"/>		<input type="checkbox"/>	<input type="checkbox"/>				
○	Ø 14 x 1,0 mm	<input type="checkbox"/>		<input type="checkbox"/>	<input type="checkbox"/>				
○	Ø 16 x 1,0 mm	<input type="checkbox"/>		<input type="checkbox"/>	<input type="checkbox"/>	<input type="checkbox"/>			
○	Ø 33,7 x 2,0 mm	<input type="checkbox"/>		<input type="checkbox"/>	<input type="checkbox"/>				
○	Ø 38 x 1,5 mm		<input type="checkbox"/>			<input type="checkbox"/>			
○	Ø 42,4 x 1,5 mm	<input type="checkbox"/>		<input type="checkbox"/>	<input type="checkbox"/>	<input type="checkbox"/>			
○	Ø 42,4 x 2,0 mm	<input type="checkbox"/>		<input type="checkbox"/>	<input type="checkbox"/>	<input type="checkbox"/>	<input type="checkbox"/>	<input type="checkbox"/>	<input type="checkbox"/>
○	Ø 42,4 x 2,6 mm	<input type="checkbox"/>		<input type="checkbox"/>	<input type="checkbox"/>	<input type="checkbox"/>			
○	Ø 48,3 x 2,0 mm	<input type="checkbox"/>		<input type="checkbox"/>	<input type="checkbox"/>	<input type="checkbox"/>			<input type="checkbox"/>
○	Ø 48,3 x 2,6 mm	<input type="checkbox"/>		<input type="checkbox"/>	<input type="checkbox"/>	<input type="checkbox"/>	<input type="checkbox"/>	<input type="checkbox"/>	
○	Ø 60,3 x 2,0 mm	<input type="checkbox"/>		<input type="checkbox"/>	<input type="checkbox"/>				

Aantal: \_\_\_\_\_

\* alleen verkrijgbaar in 5000 mm lengtes

verticale, rechte zaagsnede

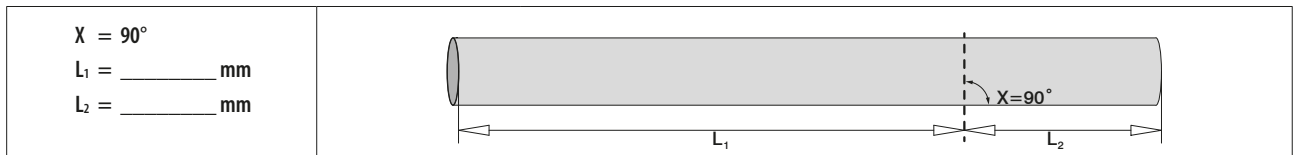

diagonale zaagsnede

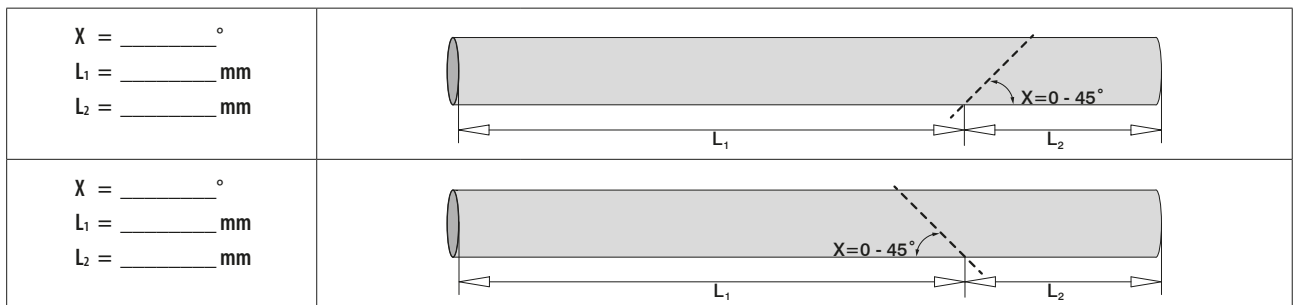

Specials

Q-railing

Afzender

Naam \_\_\_\_\_

Firma \_\_\_\_\_

Straat, nr \_\_\_\_\_

Plaats \_\_\_\_\_

Telefoon \_\_\_\_\_

Fax \_\_\_\_\_

E-mail \_\_\_\_\_

Klantnummer \_\_\_\_\_



# Zagen

(U-profiel)



		2500 mm	5000 mm	304 Geslepen	316 Geslepen	Aluminium
	17,25 x 15 x 2,0 mm	<input type="checkbox"/>	<input type="checkbox"/> *	<input type="checkbox"/>	<input type="checkbox"/>	<input type="checkbox"/>
	22 x 20 x 2,0 mm	<input type="checkbox"/>	<input type="checkbox"/> *			<input type="checkbox"/>
	26 x 20 x 2,0 mm	<input type="checkbox"/>	<input type="checkbox"/> *			<input type="checkbox"/>
Aantal: _____						* Aluminium

verticale, rechte zaagsnede

$X = 90^\circ$ $L_1 = \text{_____ mm}$ $L_2 = \text{_____ mm}$	
--	--

diagonale zaagsnede vertikaal

$X = \text{_____}^\circ$ $L_1 = \text{_____ mm}$ $L_2 = \text{_____ mm}$	
$X = \text{_____}^\circ$ $L_1 = \text{_____ mm}$ $L_2 = \text{_____ mm}$	

diagonale zaagsnede horizontaal

$X = \text{_____}^\circ$ $L_1 = \text{_____ mm}$ $L_2 = \text{_____ mm}$	
$X = \text{_____}^\circ$ $L_1 = \text{_____ mm}$ $L_2 = \text{_____ mm}$	



Afzender

Naam \_\_\_\_\_

Firma \_\_\_\_\_

Straat, nr. \_\_\_\_\_

Plaats \_\_\_\_\_

Telefoon \_\_\_\_\_

Fax \_\_\_\_\_

E-mail \_\_\_\_\_

Klantnummer \_\_\_\_\_



# Zagen

(U-profielbuis)



		2500 mm	5000 mm	304 Geslepen	316 Geslepen	304 Gepolijst	316 Gepolijst
	Ø 30 x 1,5 mm	<input type="checkbox"/>	<input type="checkbox"/>	<input type="checkbox"/>	<input type="checkbox"/>		
	Ø 42,4 x 1,5 mm	<input type="checkbox"/>	<input type="checkbox"/>	<input type="checkbox"/>	<input type="checkbox"/>	<input type="checkbox"/>	<input type="checkbox"/>
	Ø 48,3 x 1,5 mm	<input type="checkbox"/>	<input type="checkbox"/>	<input type="checkbox"/>	<input type="checkbox"/>	<input type="checkbox"/>	<input type="checkbox"/>
	Ø 60,3 x 1,5 mm	<input type="checkbox"/>	<input type="checkbox"/>	<input type="checkbox"/>	<input type="checkbox"/>		
	80 x 40 x 1,5 mm *	<input type="checkbox"/>	<input type="checkbox"/>	<input type="checkbox"/>			
	110 x 40 x 1,5 mm *	<input type="checkbox"/>	<input type="checkbox"/>	<input type="checkbox"/>			
	40 x 40 x 1,5 mm	<input type="checkbox"/>	<input type="checkbox"/>	<input type="checkbox"/>	<input type="checkbox"/>		
	60 x 40 x 1,5 mm	<input type="checkbox"/>	<input type="checkbox"/>	<input type="checkbox"/>	<input type="checkbox"/>		
Aantal: _____		* diagonale zaagsnede vertikaal 0 - 30°					

### rechte zaagsnede

$X = 90^\circ$ $L_1 = \text{_____ mm}$ $L_2 = \text{_____ mm}$	
--	--

### diagonale zaagsnede vertikaal

$X = \text{_____}^\circ$ $L_1 = \text{_____ mm}$ $L_2 = \text{_____ mm}$	
$X = \text{_____}^\circ$ $L_1 = \text{_____ mm}$ $L_2 = \text{_____ mm}$	

### diagonale zaagsnede horizontaal

$X = \text{_____}^\circ$ $L_1 = \text{_____ mm}$ $L_2 = \text{_____ mm}$	
$X = \text{_____}^\circ$ $L_1 = \text{_____ mm}$ $L_2 = \text{_____ mm}$	

#### Afzender

Naam \_\_\_\_\_

Firma \_\_\_\_\_

Straat, nr \_\_\_\_\_

Plaats \_\_\_\_\_

Telefoon \_\_\_\_\_

Fax \_\_\_\_\_

E-mail \_\_\_\_\_

Klantnummer \_\_\_\_\_



# Zagen

(hout)

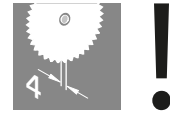

		2500 mm	3600 mm	6600 mm	Beuken onbehandeld	Beuken P11 gebeitst en gelakt	Beuken gelakt	Eiken gelakt	Ceder onbehandeld
●	Ø 42,0 mm*		<input type="checkbox"/> *	<input type="checkbox"/> *	<input type="checkbox"/>				
●	Ø 48,0 mm*		<input type="checkbox"/> *	<input type="checkbox"/> *	<input type="checkbox"/>				
●	Ø 42,0 mm	<input type="checkbox"/>			<input type="checkbox"/>	<input type="checkbox"/>	<input type="checkbox"/>	<input type="checkbox"/>	<input type="checkbox"/>
●	Ø 48,0 mm	<input type="checkbox"/>			<input type="checkbox"/>				
◐	Ø 42,0 mm	<input type="checkbox"/>				<input type="checkbox"/>	<input type="checkbox"/>	<input type="checkbox"/>	
◑	60 x 40 mm	<input type="checkbox"/>					<input type="checkbox"/>	<input type="checkbox"/>	
Aantal: _____									* Bendywood

## rechte zaagsnede

$X = 90^\circ$ $L_1 = \text{_____ mm}$ $L_2 = \text{_____ mm}$	
--	--

## diagonale zaagsnede vertikaal

$X = \text{_____}^\circ$ $L_1 = \text{_____ mm}$ $L_2 = \text{_____ mm}$	
$X = \text{_____}^\circ$ $L_1 = \text{_____ mm}$ $L_2 = \text{_____ mm}$	

## diagonale zaagsnede horizontaal

$X = \text{_____}^\circ$ $L_1 = \text{_____ mm}$ $L_2 = \text{_____ mm}$	
$X = \text{_____}^\circ$ $L_1 = \text{_____ mm}$ $L_2 = \text{_____ mm}$	



Afzender

Naam \_\_\_\_\_

Firma \_\_\_\_\_

Straat, nr. \_\_\_\_\_

Plaats \_\_\_\_\_

Telefoon \_\_\_\_\_

Fax \_\_\_\_\_

E-mail \_\_\_\_\_

Klantnummer \_\_\_\_\_



Specials

Prijsaanvraag







# Zagen

(Easy Glass® Bodemprofielen)



Zie pagina

43, 43, 46, 52, 57, 61

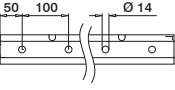
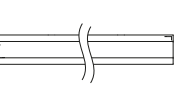
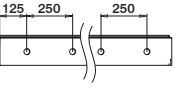
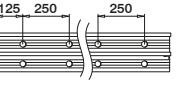
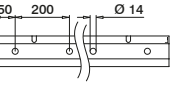
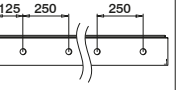
	 6904	 6914	 6905	 6903	 6908	 6907
						
<b>H x B (mm)</b>	121 x 45	121 x 45	119 x 47	200 x 60	128 x 71	126 x 73
<b>2500 mm</b>	<input type="checkbox"/>	<input type="checkbox"/>	<input type="checkbox"/>	<input type="checkbox"/>	<input type="checkbox"/>	<input type="checkbox"/>
<b>5000 mm</b>	<input type="checkbox"/>	<input type="checkbox"/>	<input type="checkbox"/>	<input type="checkbox"/>	<input type="checkbox"/>	<input type="checkbox"/>
Aantal: _____						

rechte zaagsnede

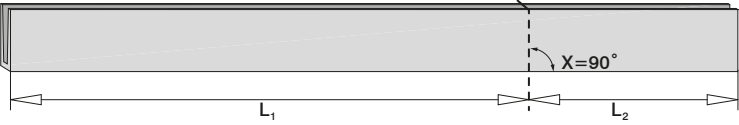
<p>X = 90°</p> <p>L<sub>1</sub> = _____ mm</p> <p>L<sub>2</sub> = _____ mm</p>	
--	---

diagonale zaagsnede vertikaal

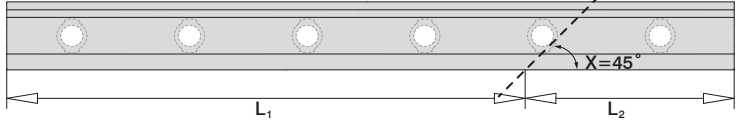
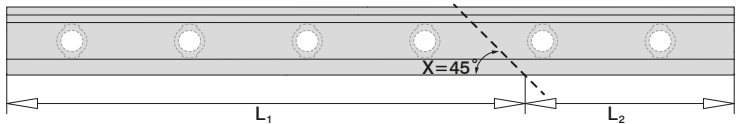
<p>X = 45°</p> <p>L<sub>1</sub> = _____ mm</p> <p>L<sub>2</sub> = _____ mm</p>	
<p>X = 45°</p> <p>L<sub>1</sub> = _____ mm</p> <p>L<sub>2</sub> = _____ mm</p>	

diagonale zaagsnede horizontaal

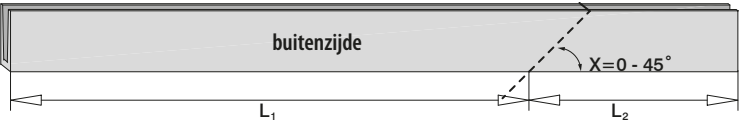
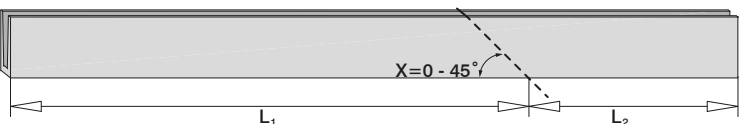
<p>X = _____ °</p> <p>L<sub>1</sub> = _____ mm</p> <p>L<sub>2</sub> = _____ mm</p>	
<p>X = _____ °</p> <p>L<sub>1</sub> = _____ mm</p> <p>L<sub>2</sub> = _____ mm</p>	

Specials

Q-railing

Afzender

Naam \_\_\_\_\_

Firma \_\_\_\_\_

Straat, nr \_\_\_\_\_

Plaats \_\_\_\_\_

Telefoon \_\_\_\_\_

Fax \_\_\_\_\_

E-mail \_\_\_\_\_

Klantnummer \_\_\_\_\_



## Q-RAILING SERVICE: OP MAAT GEBOGEN BUIS

### **Makkelijk, nauwkeurig en precies op maat**

Wilt u perfect gebogen buis of profiel in 2D of 3D? Kies dan voor Bending. U geeft de juiste maten en buigingsgraad aan. Wij zorgen voor de oplossing op maat. Zo bespaart u tijd én dure machines en u loopt u geen enkel risico.

### **Geef ons de details, dan zorgen wij voor een perfect gebogen buis**

Voor een perfect resultaat is het van belang dat wij van u alle relevante gegevens voor uw order ontvangen. We maken het u hierbij graag zo makkelijk en duidelijk mogelijk en hebben daarom een kant en klaar bestelformulier voor u ontwikkeld.

### **Graag uw zorgvuldige check op ons pre-bending tekening**

Op basis van uw ordergegevens leggen wij vervolgens de ontwerptekening aan u voor. Na uw akkoord gaan we direct met uw order aan de slag.

### **Bespaar kosten met gebogen buis in 2D**

Alle buizen die we in 2D gebogen leveren, zijn direct klaar voor montage: op maat gezaagd, gevormd volgens uw specificaties en speciaal behandeld. Vanwege het buigingsproces moeten we altijd een langere buis vervaardigen. Al het restmateriaal leveren we mee. Uiteindelijk hoeft zelf geen enkele moeite meer te doen: alleen nog even de buis afmonteren.

### **3D buigen**

Bij alle 3D buigwerkzaamheden gaan wij uit van een lineaire hellinghoek en een gelijkblijvende buigingsgraad. Na het buigen zorgen we voor een hoogwaardige nabehandeling. Hierdoor bent u verzekerd van een volledig egale oppervlaktekwaliteit en een probleemloze montage zonder extra werkzaamheden. Bovendien leveren we de buis inclusief restmateriaal. Dit wil zeggen, dat wij op de buis de snijtekens aangeven voor de door u gevraagde feitelijke afmetingen. Hierdoor heeft u bij de montage op locatie de nodige speelruimte en kunt u bouwtoleranties probleemloos opvangen.

Houdt er bij uw orders voor U-profielbuizen rekening mee, dat het glas en de montage van het glas de nodige tolerantieruimte vereisen. Wij adviseren u bij deze combinatie minimaal 5 mm speelruimte aan te houden.

### **De juiste verpakking voor een veilig transport**

We verpakken alle gebogen onderdelen zorgvuldig, klaar voor een probleemloze verzending. We raden u aan om de buis in de verpakking te houden totdat u deze gaat monteren. Zo voorkomt u verbuiging en beschadigingen zoals vlekken en krassen.

De stevige, stabiele en beschermende verpakking voorkomt schade of verbuiging tijdens transport en opslag.









# Bending 2D & 3D

(ronde buis)

		2500 mm	5000 mm	304 Geslepen	316 Geslepen	304 Gepolijst	316 Gepolijst	R <sub>min.</sub> (2D)	R <sub>min.</sub> (3D)
●	Ø 10 mm	<input type="checkbox"/>	<input type="checkbox"/>	<input type="checkbox"/>				250 mm	250 mm
●	Ø 12 mm	<input type="checkbox"/>	<input type="checkbox"/>	<input type="checkbox"/>	<input type="checkbox"/>	<input type="checkbox"/>	<input type="checkbox"/>	250 mm	250 mm
●	Ø 14 mm	<input type="checkbox"/>	<input type="checkbox"/>	<input type="checkbox"/>				250 mm	250 mm
○	Ø 16 x 1,0 mm	<input type="checkbox"/>	<input type="checkbox"/>	<input type="checkbox"/>	<input type="checkbox"/>			500 mm	500 mm
○	Ø 33,7 x 2,0 mm	<input type="checkbox"/>	<input type="checkbox"/>	<input type="checkbox"/>				500 mm	500 mm
○	Ø 42,4 x 2,0 mm	<input type="checkbox"/>	<input type="checkbox"/>	<input type="checkbox"/>	<input type="checkbox"/>	<input type="checkbox"/>	<input type="checkbox"/>	500 mm	500 mm
○	Ø 42,4 x 2,6 mm	<input type="checkbox"/>	<input type="checkbox"/>	<input type="checkbox"/>	<input type="checkbox"/>			1000 mm	1000 mm
○	Ø 48,3 x 2,0 mm	<input type="checkbox"/>	<input type="checkbox"/>	<input type="checkbox"/>	<input type="checkbox"/>			500 mm	500 mm
○	Ø 48,3 x 2,6 mm	<input type="checkbox"/>	<input type="checkbox"/>	<input type="checkbox"/>	<input type="checkbox"/>	<input type="checkbox"/>	<input type="checkbox"/>	1000 mm	1000 mm
○	Ø 60,3 x 2,0 mm	<input type="checkbox"/>	<input type="checkbox"/>	<input type="checkbox"/>				1000 mm	1000 mm
□	40 x 40 x 2,0 mm (2D only)	<input type="checkbox"/>	<input type="checkbox"/>	<input type="checkbox"/>	<input type="checkbox"/>			3500 mm	
Aantal:									

### 2D

R = \_\_\_\_\_ mm  
W = \_\_\_\_\_ °

### 3D

De effectieve lengte van een buis is bij een 3D buiging max. 3500 mm.  
Bij alle 3D buigwerkzaamheden gaan wij uit van een lineaire hellinghoek en een gelijkblijvende buigingsgraad.

Trap

D = \_\_\_\_\_ mm  
W = \_\_\_\_\_ °

Handrailing

H = \_\_\_\_\_ mm  
H1 = \_\_\_\_\_ mm  
Hp1 = \_\_\_\_\_ mm  
Hp2 = \_\_\_\_\_ mm

D = \_\_\_\_\_ mm  
W = \_\_\_\_\_ °

Links

Rechts



Afzender

Naam \_\_\_\_\_  
Firma \_\_\_\_\_  
Straat, nr. \_\_\_\_\_  
Plaats \_\_\_\_\_

Telefoon \_\_\_\_\_  
Fax \_\_\_\_\_  
E-mail \_\_\_\_\_  
Klantnummer \_\_\_\_\_



# Bending 2D

(ronde buis)

## 1 Uitvoering

Aantal

<input type="checkbox"/> <p>W: 180°</p> <p>a: _____ mm</p> <p>b: _____ mm</p>		Ø	R	X	304	316
		Ø 33,7 x 2,0 mm	67 mm <input type="checkbox"/>	134 mm	<input type="checkbox"/>	
		Ø 42,4 x 2,0 mm	64 mm <input type="checkbox"/>	128 mm	<input type="checkbox"/>	<input type="checkbox"/>
			85 mm <input type="checkbox"/>	170 mm		
		Ø 42,4 x 2,6 mm	64 mm <input type="checkbox"/>	128 mm	<input type="checkbox"/>	<input type="checkbox"/>
			85 mm <input type="checkbox"/>	170 mm		
		Ø 48,3 x 2,0 mm	73 mm <input type="checkbox"/>	146 mm	<input type="checkbox"/>	<input type="checkbox"/>
			97 mm <input type="checkbox"/>	194 mm		
		Ø 48,3 x 2,6 mm	73 mm <input type="checkbox"/>	146 mm	<input type="checkbox"/>	<input type="checkbox"/>
97 mm <input type="checkbox"/>	194 mm					
Ø 60,3 x 2,0 mm	121 mm <input type="checkbox"/>	242 mm	<input type="checkbox"/>			

## 2 Uitvoering

Aantal

<input type="checkbox"/> <p>W: _____ °</p> <p>a: _____ mm</p> <p>b: _____ mm</p>		Ø	R	304	316	
		Ø 33,7 x 2,0 mm	67 mm <input type="checkbox"/>		<input type="checkbox"/>	
		Ø 42,4 x 2,0 mm	64 mm <input type="checkbox"/>	85 mm <input type="checkbox"/>	<input type="checkbox"/>	<input type="checkbox"/>
			64 mm <input type="checkbox"/>	85 mm <input type="checkbox"/>		
		Ø 48,3 x 2,0 mm	73 mm <input type="checkbox"/>	97 mm <input type="checkbox"/>	<input type="checkbox"/>	<input type="checkbox"/>
			73 mm <input type="checkbox"/>	97 mm <input type="checkbox"/>	<input type="checkbox"/>	<input type="checkbox"/>
		Ø 60,3 x 2,0 mm	121 mm <input type="checkbox"/>		<input type="checkbox"/>	

Afzender

Naam \_\_\_\_\_

Telefoon \_\_\_\_\_

Firma \_\_\_\_\_

Fax \_\_\_\_\_

Straat, nr. \_\_\_\_\_

E-mail \_\_\_\_\_

Plaats \_\_\_\_\_

Klantnummer \_\_\_\_\_



# Bending 2D

(ronde buis)

## 3 Uitvoering

Aantal

<input type="checkbox"/> <p>W: _____ ° a: _____ mm b: _____ mm</p>	Ø	R	304	316		
	Ø 33,7 x 2,0 mm	67 mm <input type="checkbox"/>		<input type="checkbox"/>		
	Ø 42,4 x 2,0 mm	64 mm <input type="checkbox"/>	85 mm <input type="checkbox"/>	<input type="checkbox"/>	<input type="checkbox"/>	
	Ø 42,4 x 2,6 mm	64 mm <input type="checkbox"/>	85 mm <input type="checkbox"/>	<input type="checkbox"/>	<input type="checkbox"/>	
	Ø 48,3 x 2,0 mm	73 mm <input type="checkbox"/>	97 mm <input type="checkbox"/>	<input type="checkbox"/>	<input type="checkbox"/>	
	Ø 48,3 x 2,6 mm	73 mm <input type="checkbox"/>	97 mm <input type="checkbox"/>	<input type="checkbox"/>	<input type="checkbox"/>	
	Ø 60,3 x 2,0 mm	121 mm <input type="checkbox"/>		<input type="checkbox"/>		

## 4a Uitvoering

Aantal

<input type="checkbox"/> <p>W: _____ ° a: _____ mm b: _____ mm c: _____ mm</p>	Ø	R	304	316		
	Ø 33,7 x 2,0 mm	67 mm <input type="checkbox"/>		<input type="checkbox"/>		
	Ø 42,4 x 2,0 mm	64 mm <input type="checkbox"/>	85 mm <input type="checkbox"/>	<input type="checkbox"/>	<input type="checkbox"/>	
	Ø 42,4 x 2,6 mm	64 mm <input type="checkbox"/>	85 mm <input type="checkbox"/>	<input type="checkbox"/>	<input type="checkbox"/>	
	Ø 48,3 x 2,0 mm	73 mm <input type="checkbox"/>	97 mm <input type="checkbox"/>	<input type="checkbox"/>	<input type="checkbox"/>	
	Ø 48,3 x 2,6 mm	73 mm <input type="checkbox"/>	97 mm <input type="checkbox"/>	<input type="checkbox"/>	<input type="checkbox"/>	
	Ø 60,3 x 2,0 mm	121 mm <input type="checkbox"/>		<input type="checkbox"/>		



Afzender

Naam \_\_\_\_\_  
Firma \_\_\_\_\_  
Straat, nr. \_\_\_\_\_  
Plaats \_\_\_\_\_

Telefoon \_\_\_\_\_  
Fax \_\_\_\_\_  
E-mail \_\_\_\_\_  
Klantnummer \_\_\_\_\_



# Bending 2D

(ronde buis)

**4b** Uitvoering

Aantal



W: \_\_\_\_\_ °

a: \_\_\_\_\_ mm

b: \_\_\_\_\_ mm

c: \_\_\_\_\_ mm

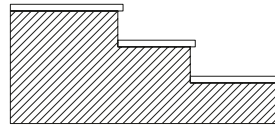
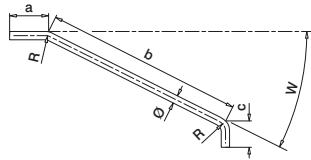

	Ø	R		Aantal		
		304	316			
	Ø 33,7 x 2,0 mm	67 mm <input type="checkbox"/>		<input type="checkbox"/>		
	Ø 42,4 x 2,0 mm	64 mm <input type="checkbox"/>	85 mm <input type="checkbox"/>	<input type="checkbox"/>	<input type="checkbox"/>	
	Ø 42,4 x 2,6 mm	64 mm <input type="checkbox"/>	85 mm <input type="checkbox"/>	<input type="checkbox"/>	<input type="checkbox"/>	
	Ø 48,3 x 2,0 mm	73 mm <input type="checkbox"/>	97 mm <input type="checkbox"/>	<input type="checkbox"/>	<input type="checkbox"/>	
	Ø 48,3 x 2,6 mm	73 mm <input type="checkbox"/>	97 mm <input type="checkbox"/>	<input type="checkbox"/>	<input type="checkbox"/>	
	Ø 60,3 x 2,0 mm	121 mm <input type="checkbox"/>		<input type="checkbox"/>		

Afzender

Naam \_\_\_\_\_

Telefoon \_\_\_\_\_

Firma \_\_\_\_\_

Fax \_\_\_\_\_

Straat, nr. \_\_\_\_\_

E-mail \_\_\_\_\_

Plaats \_\_\_\_\_

Klantnummer \_\_\_\_\_



# Bending 2D

(ronde buis)

## 5 Uitvoering

Aantal

<input type="checkbox"/> <p>a: _____ mm</p> <p>b: _____ mm</p> <p>c: _____ mm</p>		Ø	R	304	316		
		Ø 33,7 x 2,0 mm	67 mm <input type="checkbox"/>		<input type="checkbox"/>		
		Ø 42,4 x 2,0 mm	64 mm <input type="checkbox"/>	85 mm <input type="checkbox"/>	<input type="checkbox"/>	<input type="checkbox"/>	
		Ø 42,4 x 2,6 mm	64 mm <input type="checkbox"/>	85 mm <input type="checkbox"/>	<input type="checkbox"/>	<input type="checkbox"/>	
		Ø 48,3 x 2,0 mm	73 mm <input type="checkbox"/>	97 mm <input type="checkbox"/>	<input type="checkbox"/>	<input type="checkbox"/>	
		Ø 48,3 x 2,6 mm	73 mm <input type="checkbox"/>	97 mm <input type="checkbox"/>	<input type="checkbox"/>	<input type="checkbox"/>	
		Ø 60,3 x 2,0 mm	121 mm <input type="checkbox"/>		<input type="checkbox"/>		

## 6 Uitvoering

Aantal

<input type="checkbox"/> <p>W: _____ °</p> <p>a: _____ mm</p> <p>b: _____ mm</p> <p>c: _____ mm</p> <p>d: _____ mm</p>		Ø	R	304	316		
		Ø 33,7 x 2,0 mm	67 mm <input type="checkbox"/>		<input type="checkbox"/>		
		Ø 42,4 x 2,0 mm	64 mm <input type="checkbox"/>	85 mm <input type="checkbox"/>	<input type="checkbox"/>	<input type="checkbox"/>	
		Ø 42,4 x 2,6 mm	64 mm <input type="checkbox"/>	85 mm <input type="checkbox"/>	<input type="checkbox"/>	<input type="checkbox"/>	
		Ø 48,3 x 2,0 mm	73 mm <input type="checkbox"/>	97 mm <input type="checkbox"/>	<input type="checkbox"/>	<input type="checkbox"/>	
		Ø 48,3 x 2,6 mm	73 mm <input type="checkbox"/>	97 mm <input type="checkbox"/>	<input type="checkbox"/>	<input type="checkbox"/>	
		Ø 60,3 x 2,0 mm	121 mm <input type="checkbox"/>		<input type="checkbox"/>		



Afzender

Naam \_\_\_\_\_

Firma \_\_\_\_\_

Straat, nr. \_\_\_\_\_

Plaats \_\_\_\_\_

Telefoon \_\_\_\_\_

Fax \_\_\_\_\_

E-mail \_\_\_\_\_

Klantnummer \_\_\_\_\_



# Bending 2D

(ronde buis)

## 7 Uitvoering

Aantal

<input type="checkbox"/> <p>W: _____ °</p> <p>a: _____ mm</p> <p>b: _____ mm</p> <p>c: _____ mm</p>		Ø	R	304	316	
		Ø 33,7 x 2,0 mm	67 mm <input type="checkbox"/>		<input type="checkbox"/>	
		Ø 42,4 x 2,0 mm	64 mm <input type="checkbox"/>	85 mm <input type="checkbox"/>	<input type="checkbox"/>	<input type="checkbox"/>
		Ø 42,4 x 2,6 mm	64 mm <input type="checkbox"/>	85 mm <input type="checkbox"/>	<input type="checkbox"/>	<input type="checkbox"/>
		Ø 48,3 x 2,0 mm	73 mm <input type="checkbox"/>	97 mm <input type="checkbox"/>	<input type="checkbox"/>	<input type="checkbox"/>
		Ø 48,3 x 2,6 mm	73 mm <input type="checkbox"/>	97 mm <input type="checkbox"/>	<input type="checkbox"/>	<input type="checkbox"/>
		Ø 60,3 x 2,0 mm	121 mm <input type="checkbox"/>		<input type="checkbox"/>	

## 8 Uitvoering

Aantal

<input type="checkbox"/> <p>W: _____ °</p> <p>a: _____ mm</p> <p>b: _____ mm</p> <p>c: _____ mm</p> <p>d: _____ mm</p>		Ø	R	304	316	
		Ø 33,7 x 2,0 mm	67 mm <input type="checkbox"/>		<input type="checkbox"/>	
		Ø 42,4 x 2,0 mm	64 mm <input type="checkbox"/>	85 mm <input type="checkbox"/>	<input type="checkbox"/>	<input type="checkbox"/>
		Ø 42,4 x 2,6 mm	64 mm <input type="checkbox"/>	85 mm <input type="checkbox"/>	<input type="checkbox"/>	<input type="checkbox"/>
		Ø 48,3 x 2,0 mm	73 mm <input type="checkbox"/>	97 mm <input type="checkbox"/>	<input type="checkbox"/>	<input type="checkbox"/>
		Ø 48,3 x 2,6 mm	73 mm <input type="checkbox"/>	97 mm <input type="checkbox"/>	<input type="checkbox"/>	<input type="checkbox"/>
		Ø 60,3 x 2,0 mm	121 mm <input type="checkbox"/>		<input type="checkbox"/>	

Afzender

Naam \_\_\_\_\_

Telefoon \_\_\_\_\_

Firma \_\_\_\_\_

Fax \_\_\_\_\_

Straat, nr. \_\_\_\_\_

E-mail \_\_\_\_\_

Plaats \_\_\_\_\_

Klantnummer \_\_\_\_\_



# Bending 2D

(ronde buis)

## 9 Uitvoering

Aantal

<input type="checkbox"/> <p>W: _____ °</p> <p>a: _____ mm</p> <p>b: _____ mm</p> <p>c: _____ mm</p> <p>d: _____ mm</p>		Ø	R	304	316		
		Ø 33,7 x 2,0 mm	67 mm		<input type="checkbox"/>		
		Ø 42,4 x 2,0 mm	64 mm	85 mm	<input type="checkbox"/>	<input type="checkbox"/>	
		Ø 42,4 x 2,6 mm	64 mm	85 mm	<input type="checkbox"/>	<input type="checkbox"/>	
		Ø 48,3 x 2,0 mm	73 mm	97 mm	<input type="checkbox"/>	<input type="checkbox"/>	
		Ø 48,3 x 2,6 mm	73 mm	97 mm	<input type="checkbox"/>	<input type="checkbox"/>	
		Ø 60,3 x 2,0 mm	121 mm		<input type="checkbox"/>		

## 10 Uitvoering

Aantal

<input type="checkbox"/> <p>W: _____ °</p> <p>a: _____ mm</p> <p>b: _____ mm</p> <p>c: _____ mm</p> <p>d: _____ mm</p> <p>e: _____ mm</p>		Ø	R	304	316		
		Ø 33,7 x 2,0 mm	67 mm		<input type="checkbox"/>		
		Ø 42,4 x 2,0 mm	64 mm	85 mm	<input type="checkbox"/>	<input type="checkbox"/>	
		Ø 42,4 x 2,6 mm	64 mm	85 mm	<input type="checkbox"/>	<input type="checkbox"/>	
		Ø 48,3 x 2,0 mm	73 mm	97 mm	<input type="checkbox"/>	<input type="checkbox"/>	
		Ø 48,3 x 2,6 mm	73 mm	97 mm	<input type="checkbox"/>	<input type="checkbox"/>	
		Ø 60,3 x 2,0 mm	121 mm		<input type="checkbox"/>		



Afzender

Naam \_\_\_\_\_

Firma \_\_\_\_\_

Straat, nr. \_\_\_\_\_

Plaats \_\_\_\_\_

Telefoon \_\_\_\_\_

Fax \_\_\_\_\_

E-mail \_\_\_\_\_

Klantnummer \_\_\_\_\_



# Bending 2D

(ronde buis)

11

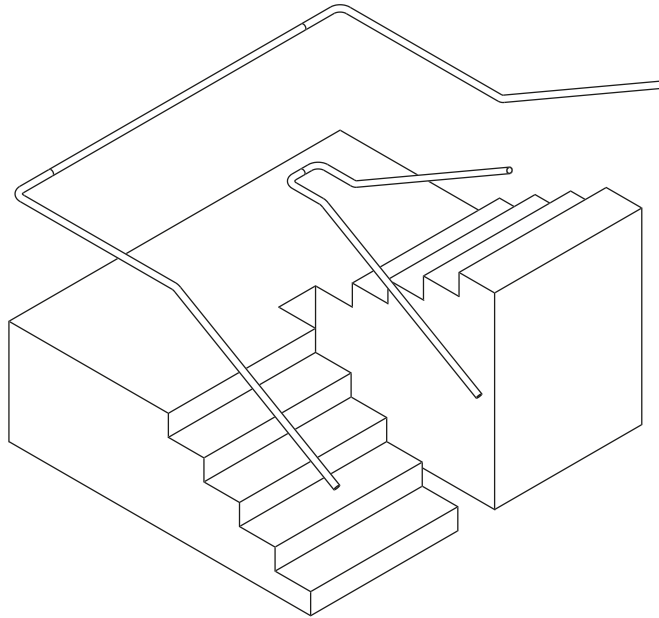

11a Uitvoering

Aantal

<input type="checkbox"/> <p>W1: _____ °</p> <p>W2: _____ °</p> <p>a: _____ mm</p> <p>b: _____ mm</p> <p>c: _____ mm</p>		Ø	R	304	316		
		Ø 33,7 x 2,0 mm	67 mm <input type="checkbox"/>		<input type="checkbox"/>		
		Ø 42,4 x 2,0 mm	64 mm <input type="checkbox"/>	85 mm <input type="checkbox"/>	<input type="checkbox"/>	<input type="checkbox"/>	
		Ø 42,4 x 2,6 mm	64 mm <input type="checkbox"/>	85 mm <input type="checkbox"/>	<input type="checkbox"/>	<input type="checkbox"/>	
		Ø 48,3 x 2,0 mm	73 mm <input type="checkbox"/>	97 mm <input type="checkbox"/>	<input type="checkbox"/>	<input type="checkbox"/>	
		Ø 48,3 x 2,6 mm	73 mm <input type="checkbox"/>	97 mm <input type="checkbox"/>	<input type="checkbox"/>	<input type="checkbox"/>	
		Ø 60,3 x 2,0 mm	121 mm <input type="checkbox"/>		<input type="checkbox"/>		

Afzender

Naam \_\_\_\_\_

Firma \_\_\_\_\_

Straat, nr. \_\_\_\_\_

Plaats \_\_\_\_\_

Telefoon \_\_\_\_\_

Fax \_\_\_\_\_

E-mail \_\_\_\_\_

Klantnummer \_\_\_\_\_





# Bending 2D

(ronde buis)

## 11b Uitvoering

Aantal

<input type="checkbox"/> <p>W1: _____ °</p> <p>W2: _____ °</p> <p>a: _____ mm</p> <p>b: _____ mm</p> <p>c: _____ mm</p>		Ø	R	304	316		
		Ø 33,7 x 2,0 mm	67 mm		<input type="checkbox"/>		
		Ø 42,4 x 2,0 mm	64 mm	85 mm	<input type="checkbox"/>	<input type="checkbox"/>	
		Ø 42,4 x 2,6 mm	64 mm	85 mm	<input type="checkbox"/>	<input type="checkbox"/>	
		Ø 48,3 x 2,0 mm	73 mm	97 mm	<input type="checkbox"/>	<input type="checkbox"/>	
		Ø 48,3 x 2,6 mm	73 mm	97 mm	<input type="checkbox"/>	<input type="checkbox"/>	
		Ø 60,3 x 2,0 mm	121 mm		<input type="checkbox"/>		

## 11c Uitvoering

Aantal

<input type="checkbox"/> <p>W1: _____ °</p> <p>W2: _____ °</p> <p>a: _____ mm</p> <p>b: _____ mm</p> <p>c: _____ mm</p> <p>d: _____ mm</p> <p>e: _____ mm</p>		Ø	R	304	316		
		Ø 33,7 x 2,0 mm	67 mm		<input type="checkbox"/>		
		Ø 42,4 x 2,0 mm	64 mm	85 mm	<input type="checkbox"/>	<input type="checkbox"/>	
		Ø 42,4 x 2,6 mm	64 mm	85 mm	<input type="checkbox"/>	<input type="checkbox"/>	
		Ø 48,3 x 2,0 mm	73 mm	97 mm	<input type="checkbox"/>	<input type="checkbox"/>	
		Ø 48,3 x 2,6 mm	73 mm	97 mm	<input type="checkbox"/>	<input type="checkbox"/>	
		Ø 60,3 x 2,0 mm	121 mm		<input type="checkbox"/>		



Afzender

Naam \_\_\_\_\_

Firma \_\_\_\_\_

Straat, nr. \_\_\_\_\_

Plaats \_\_\_\_\_

Telefoon \_\_\_\_\_

Fax \_\_\_\_\_

E-mail \_\_\_\_\_

Klantnummer \_\_\_\_\_



Specials

Prijsaanvraag

# Bending 2D

(ronde buis)

12

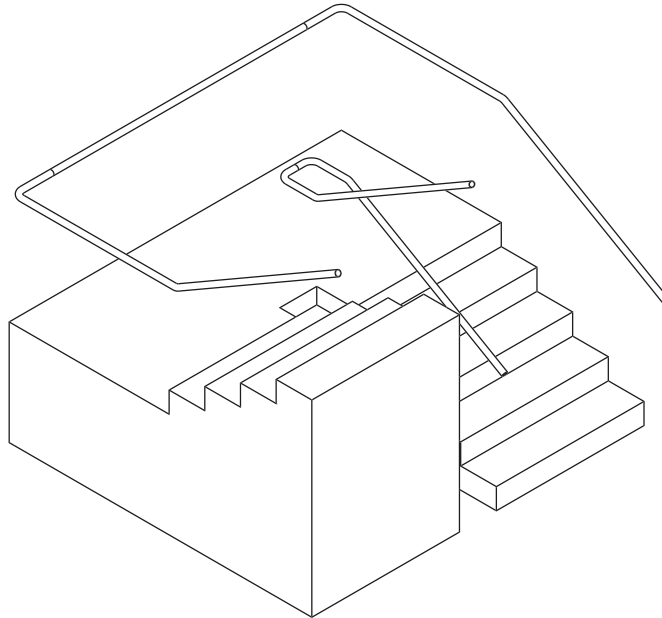

12a Uitvoering

Aantal



W1: \_\_\_\_\_ °  
 W2: \_\_\_\_\_ °  
 a: \_\_\_\_\_ mm  
 b: \_\_\_\_\_ mm  
 c: \_\_\_\_\_ mm

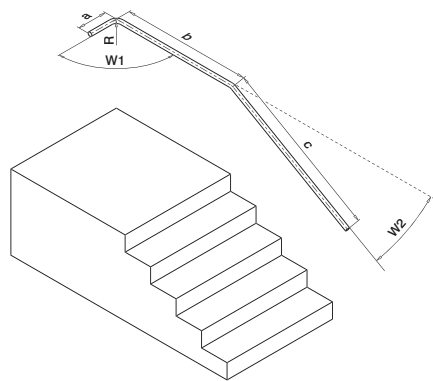

	Ø	R	
	Ø 33,7 x 2,0 mm	67 mm	<input type="checkbox"/>
	Ø 42,4 x 2,0 mm	64 mm	85 mm <input type="checkbox"/>
	Ø 42,4 x 2,6 mm	64 mm	85 mm <input type="checkbox"/>
	Ø 48,3 x 2,0 mm	73 mm	97 mm <input type="checkbox"/>
	Ø 48,3 x 2,6 mm	73 mm	97 mm <input type="checkbox"/>
	Ø 60,3 x 2,0 mm	121 mm	<input type="checkbox"/>

	304	316	
	<input type="checkbox"/>	<input type="checkbox"/>	
	<input type="checkbox"/>	<input type="checkbox"/>	
	<input type="checkbox"/>	<input type="checkbox"/>	
	<input type="checkbox"/>	<input type="checkbox"/>	
	<input type="checkbox"/>	<input type="checkbox"/>	
	<input type="checkbox"/>	<input type="checkbox"/>	

Specials



Afzender

Naam \_\_\_\_\_  
 Firma \_\_\_\_\_  
 Straat, nr. \_\_\_\_\_  
 Plaats \_\_\_\_\_

Telefoon \_\_\_\_\_  
 Fax \_\_\_\_\_  
 E-mail \_\_\_\_\_  
 Klantnummer \_\_\_\_\_



# Bending 2D

(ronde buis)

## 12b Uitvoering

Aantal

<input type="checkbox"/> <p>W1: _____ °</p> <p>W2: _____ °</p> <p>a: _____ mm</p> <p>b: _____ mm</p> <p>c: _____ mm</p>		∅	R	304	316		
		∅ 33,7 x 2,0 mm	67 mm		<input type="checkbox"/>		
		∅ 42,4 x 2,0 mm	64 mm	85 mm	<input type="checkbox"/>	<input type="checkbox"/>	
		∅ 42,4 x 2,6 mm	64 mm	85 mm	<input type="checkbox"/>	<input type="checkbox"/>	
		∅ 48,3 x 2,0 mm	73 mm	97 mm	<input type="checkbox"/>	<input type="checkbox"/>	
		∅ 48,3 x 2,6 mm	73 mm	97 mm	<input type="checkbox"/>	<input type="checkbox"/>	
		∅ 60,3 x 2,0 mm	121 mm		<input type="checkbox"/>		

## 12c Uitvoering

Aantal

<input type="checkbox"/> <p>W1: _____ °</p> <p>W2: _____ °</p> <p>a: _____ mm</p> <p>b: _____ mm</p> <p>c: _____ mm</p>		∅	R	304	316		
		∅ 33,7 x 2,0 mm	67 mm		<input type="checkbox"/>		
		∅ 42,4 x 2,0 mm	64 mm	85 mm	<input type="checkbox"/>	<input type="checkbox"/>	
		∅ 42,4 x 2,6 mm	64 mm	85 mm	<input type="checkbox"/>	<input type="checkbox"/>	
		∅ 48,3 x 2,0 mm	73 mm	97 mm	<input type="checkbox"/>	<input type="checkbox"/>	
		∅ 48,3 x 2,6 mm	73 mm	97 mm	<input type="checkbox"/>	<input type="checkbox"/>	
		∅ 60,3 x 2,0 mm	121 mm		<input type="checkbox"/>		



Afzender

Naam \_\_\_\_\_

Firma \_\_\_\_\_

Straat, nr. \_\_\_\_\_

Plaats \_\_\_\_\_

Telefoon \_\_\_\_\_

Fax \_\_\_\_\_

E-mail \_\_\_\_\_

Klantnummer \_\_\_\_\_



# Bending 2D

(ronde buis)

## 13 Uitvoering

Aantal

<input type="checkbox"/> <p>W: _____ °</p> <p>a: _____ mm</p> <p>b: _____ mm</p> <p>c: _____ mm</p> <p>d: _____ mm</p> <p>Xmin 120 mm</p>		Ø		R		304	316		
		Ø 42,2 x 2,0 mm	64 mm	85 mm	<input type="checkbox"/>	<input type="checkbox"/>	<input type="checkbox"/>	<input type="checkbox"/>	
		Ø 42,2 x 2,6 mm	64 mm	85 mm	<input type="checkbox"/>	<input type="checkbox"/>	<input type="checkbox"/>	<input type="checkbox"/>	
		Ø 48,3 x 2,0 mm	73 mm	97 mm	<input type="checkbox"/>	<input type="checkbox"/>	<input type="checkbox"/>	<input type="checkbox"/>	
		Ø 48,3 x 2,6 mm	73 mm	97 mm	<input type="checkbox"/>	<input type="checkbox"/>	<input type="checkbox"/>	<input type="checkbox"/>	

## 14a Uitvoering

Aantal

<input type="checkbox"/> <p>W: _____ °</p> <p>a: _____ mm</p> <p>b: _____ mm</p> <p>c: _____ mm</p> <p>d: _____ mm</p> <p>Xmin 120 mm</p>		Ø		R		304	316		
		Ø 42,2 x 2,0 mm	64 mm	85 mm	<input type="checkbox"/>	<input type="checkbox"/>	<input type="checkbox"/>	<input type="checkbox"/>	
		Ø 42,2 x 2,6 mm	64 mm	85 mm	<input type="checkbox"/>	<input type="checkbox"/>	<input type="checkbox"/>	<input type="checkbox"/>	
		Ø 48,3 x 2,0 mm	73 mm	97 mm	<input type="checkbox"/>	<input type="checkbox"/>	<input type="checkbox"/>	<input type="checkbox"/>	
		Ø 48,3 x 2,6 mm	73 mm	97 mm	<input type="checkbox"/>	<input type="checkbox"/>	<input type="checkbox"/>	<input type="checkbox"/>	

Afzender

Naam \_\_\_\_\_

Telefoon \_\_\_\_\_

Firma \_\_\_\_\_

Fax \_\_\_\_\_

Straat, nr. \_\_\_\_\_

E-mail \_\_\_\_\_

Plaats \_\_\_\_\_

Klantnummer \_\_\_\_\_



# Boren

(ronde buis)

Specials

Prijsaanvraag

## 14b Uitvoering



H1: \_\_\_\_\_ mm

H2: \_\_\_\_\_ mm

H3: \_\_\_\_\_ mm

H4: \_\_\_\_\_ mm

ØB: \_\_\_\_\_ mm

W: \_\_\_\_\_ °

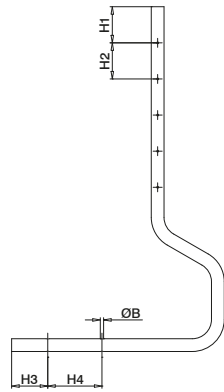

Type

Aantal

Aantal

Draadtappen

H1/H2	
<input type="checkbox"/>	
<input type="checkbox"/>	
<input type="checkbox"/>	
<input type="checkbox"/>	
<input type="checkbox"/>	
<input type="checkbox"/>	
<input type="checkbox"/>	

Buizen	Gaten	Ø mm	Draadtappen		
			M6	M8	M10
			<input type="checkbox"/>	<input type="checkbox"/>	<input type="checkbox"/>
			<input type="checkbox"/>	<input type="checkbox"/>	<input type="checkbox"/>
			<input type="checkbox"/>	<input type="checkbox"/>	<input type="checkbox"/>
			<input type="checkbox"/>	<input type="checkbox"/>	<input type="checkbox"/>
			<input type="checkbox"/>	<input type="checkbox"/>	<input type="checkbox"/>
			<input type="checkbox"/>	<input type="checkbox"/>	<input type="checkbox"/>
			<input type="checkbox"/>	<input type="checkbox"/>	<input type="checkbox"/>



Afzender

Naam \_\_\_\_\_

Telefoon \_\_\_\_\_

Firma \_\_\_\_\_

Fax \_\_\_\_\_

Straat, nr. \_\_\_\_\_

E-mail \_\_\_\_\_

Plaats \_\_\_\_\_

Klantnummer \_\_\_\_\_











Specials

Prijsaanvraag

# Bending 2D

(U-profielbuis)

		304 Geslepen	316 Geslepen	304 Gepolijst	316 Gepolijst	R <sub>min.</sub> (2D)*				
	∅ 42,4 x 1,5 mm	<input type="checkbox"/>	<input type="checkbox"/>	<input type="checkbox"/>	<input type="checkbox"/>	1000 mm	<input type="checkbox"/>	<input type="checkbox"/>	<input type="checkbox"/>	<input type="checkbox"/>
	∅ 48,3 x 1,5 mm	<input type="checkbox"/>	<input type="checkbox"/>	<input type="checkbox"/>	<input type="checkbox"/>	1000 mm	<input type="checkbox"/>	<input type="checkbox"/>	<input type="checkbox"/>	<input type="checkbox"/>
	∅ 60,3 x 1,5 mm	<input type="checkbox"/>				2000 mm	<input type="checkbox"/>	<input type="checkbox"/>	<input type="checkbox"/>	<input type="checkbox"/>
	80 x 40 x 1,5 mm	<input type="checkbox"/>				750 mm	<input type="checkbox"/>		<input type="checkbox"/>	
	40 x 40 x 1,5 mm	<input type="checkbox"/>	<input type="checkbox"/>			3500 mm	<input type="checkbox"/>		<input type="checkbox"/>	
Aantal:						*Een kleinere radius alleen op aanvraag.				

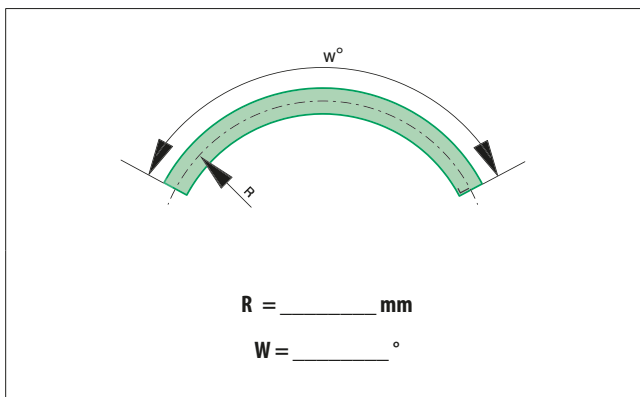

Specials



Afzender

Naam

Telefoon

Firma

Fax

Straat, nr.

E-mail

Plaats

Klantnummer



# Bending 3D

(U-profielbuis, rond)

		304 Geslepen	316 Geslepen	304 Gepolijst	316 Gepolijst	R <sub>min.</sub> (3D)*	T <sub>max.</sub> (3D)
	Ø 42,4 x 1,5 mm	<input type="checkbox"/>	<input type="checkbox"/>	<input type="checkbox"/>	<input type="checkbox"/>	1000 mm	19 mm
	Ø 48,3 x 1,5 mm	<input type="checkbox"/>	<input type="checkbox"/>	<input type="checkbox"/>	<input type="checkbox"/>	1000 mm	21,52 mm
	Ø 60,3 x 1,5 mm	<input type="checkbox"/>	<input type="checkbox"/>			2000 mm	25,52 mm
Aantal:						*Een kleinere radius alleen op aanvraag.	

**3D**

De effectieve lengte van een buis is bij een 3D buiging max. 3500 mm.  
Bij alle 3D buigwerkzaamheden gaan wij uit van een lineaire hellinghoek en een gelijkblijvende buigingsgraad.

Links

Rechts

H = \_\_\_\_\_ mm

H1 = \_\_\_\_\_ mm

Hg1 = \_\_\_\_\_ mm

H0 = \_\_\_\_\_ mm

H2 = \_\_\_\_\_ mm

Hg2 = \_\_\_\_\_ mm

D = \_\_\_\_\_ mm

W<sub>glas</sub> = \_\_\_\_\_ °



Afzender

Naam \_\_\_\_\_

Firma \_\_\_\_\_

Straat, nr. \_\_\_\_\_

Plaats \_\_\_\_\_

Telefoon \_\_\_\_\_

Fax \_\_\_\_\_

E-mail \_\_\_\_\_

Klantnummer \_\_\_\_\_







## DISPLAYS: TOEPASSINGS- MOGELIJKHEDEN VAN Q-RAILING ZICHTBAAR VOOR UW KLANTEN.



Specials

### Displays

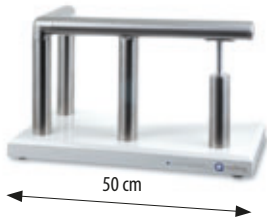

**MOD 0004**

Display

15.0004.000.00 Railingsystemen - RVS

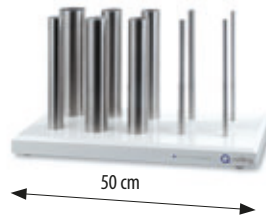

**MOD 0007**

Display

15.0007.000.00 Buis en staf - RVS

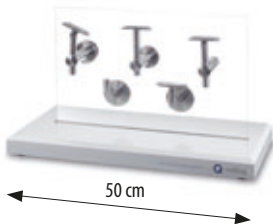

**MOD 0006**

Display

15.0006.000.00 Handrailingsteunen - RVS



**MOD 0024**

Display

15.0024.000.00 Naturail

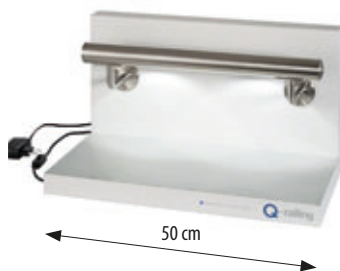

**MOD 0337**

Display

15.0337.000.00 LED-spots

Displays

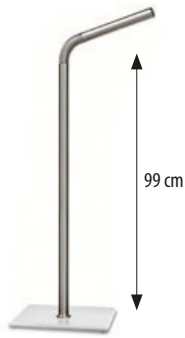

**MOD 0015**

Display

15.0015.000.00 Flex Connect®

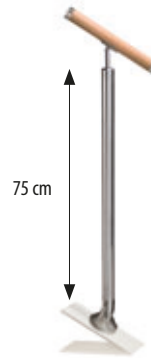

**MOD 0029**

Display

15.0029.000.00 Verstelbare balustervoet



**MOD 0303**

Display

15.0303.000.00 Q-glass

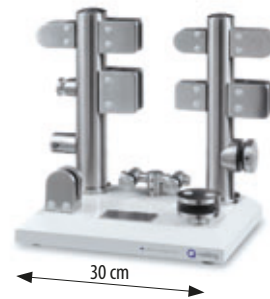

**MOD 0335**

Display

15.0335.000.00 Glasklemmen

Promotie



**MOD 0037**

Promobox

15.0037.000.00 Ultra Range



**Promobox Easy Glass®**

9000.0000.002.70 Promobox Easy Glass® Evo

9000.0000.003.42 Promobox Easy Glass® 3kN

9000.0000.003.49 Promobox Easy Glass® Slim, zijmontage

9000.0000.004.75 Promobox Easy Glass® Slim, topmontage



**MOD 0050**

**Promoset**

15.0050.000.00 Fast Fix



**MOD 0012**

**Promoportfolio**

15.0012.000.00 Easy Q-Web®



**Q-video**

9000.0000.000.39 Montagevideo (D, GB)



**Q-video**

9000.0000.003.27 Q-railing corporate video, (D, GB, DK, NL)



**Easy Glass® brochure**

Bestel uw eigen exemplaar



**Q-inspirations brochure**

Bestel uw eigen exemplaar

**NEW**



**Q-designs brochure**

Bestel uw eigen exemplaar



**Q-designs 2 brochure**

Bestel uw eigen exemplaar